



0.75mm thick elastomer 0.8mm pitch BGA
S-Parameter simulation (G-S-S-G configuration)

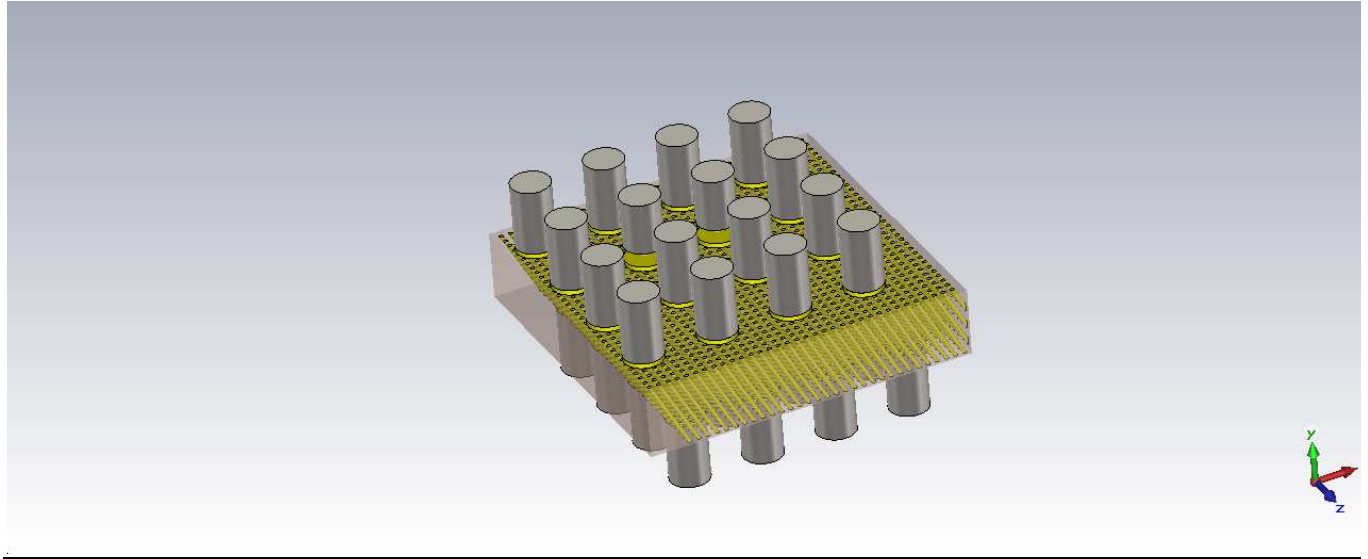

Fig. 1: 3D model for S-Parameter simulation data (G-S-S-G configuration)

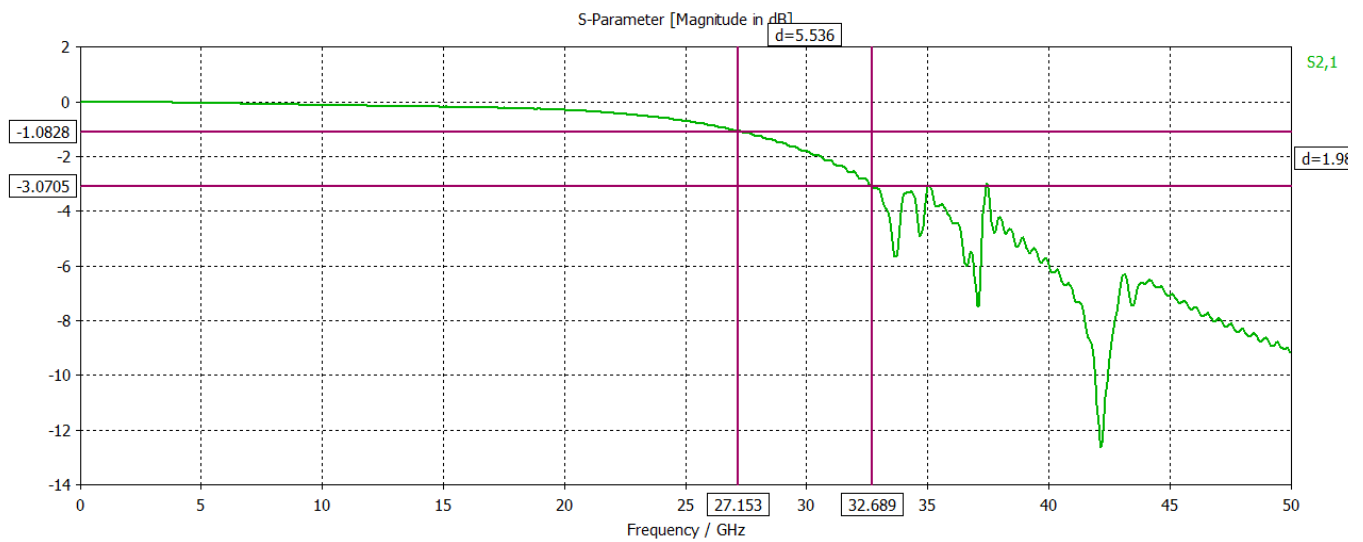

Fig. 2: Simulated Insertion loss

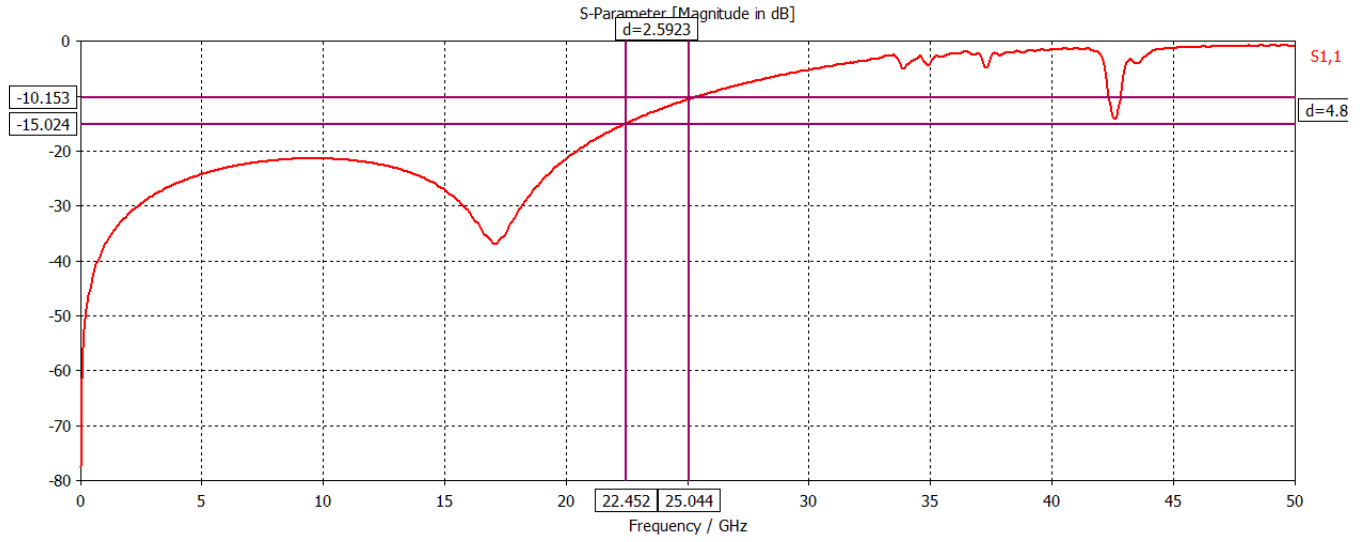

Fig. 3: Simulated Return Loss S1,1

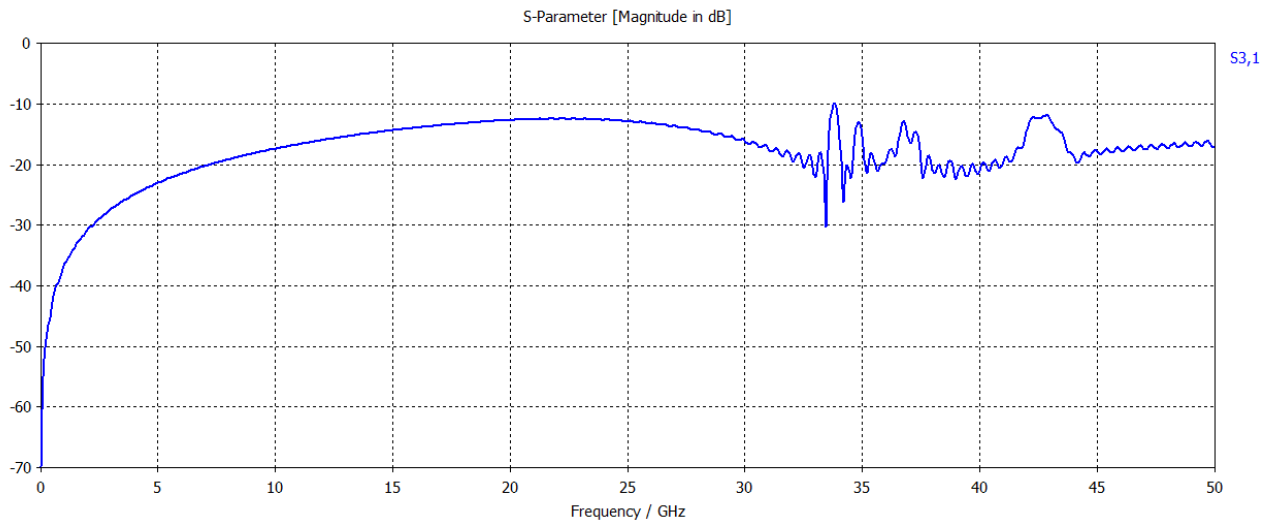

Fig.4 : Crosstalk. S31



Ironwood
ELECTRONICS

Tel: (800) 404-0204 • (952) 229-8200

Fax: (952) 229-8201

www.ironwoodelectronics.com

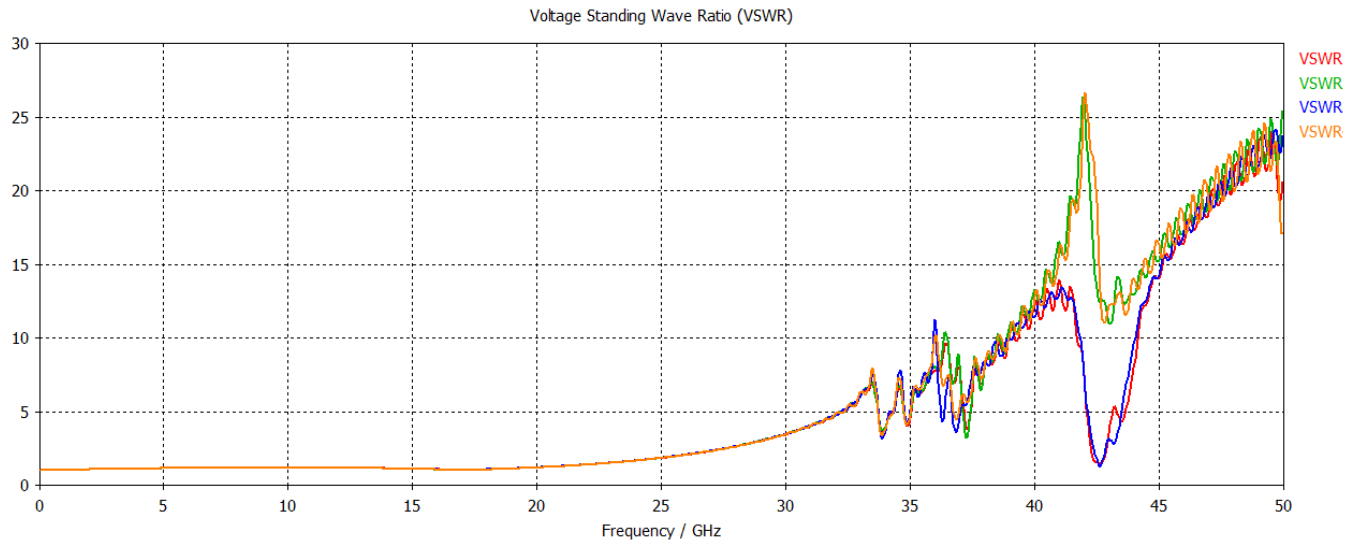

Fig.5 : VSWR



0.75mm thick elastomer 0.8mm pitch BGA
S-Parameter simulation (G-S-G configuration)

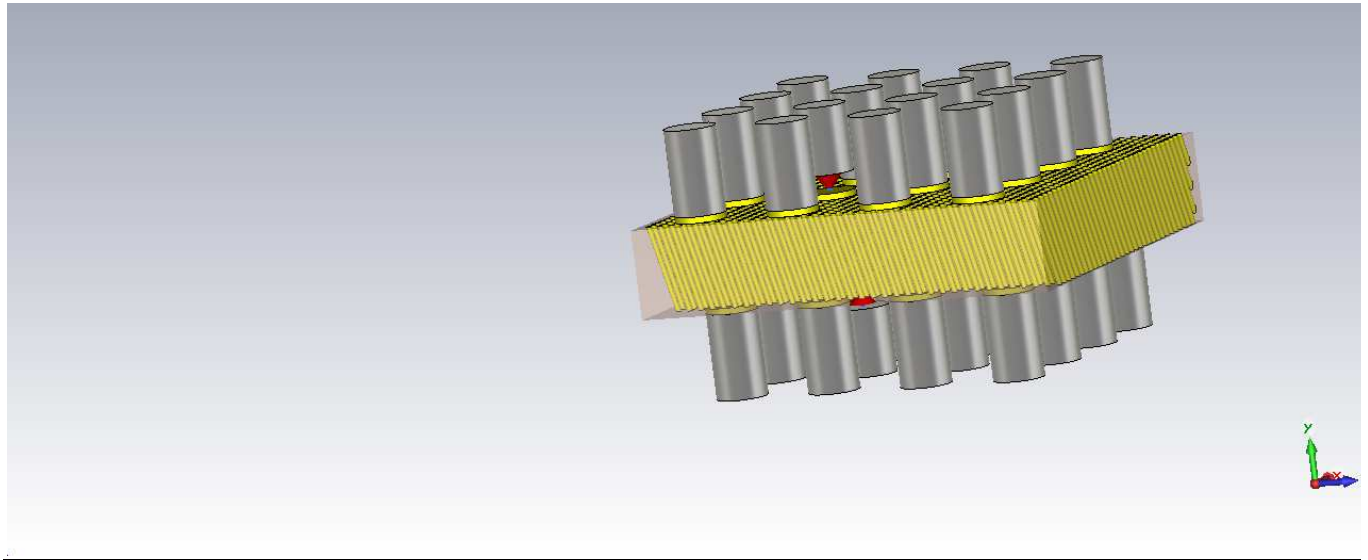

Fig. 1: 3D model for S-Parameter simulation data (G-S-G configuration)

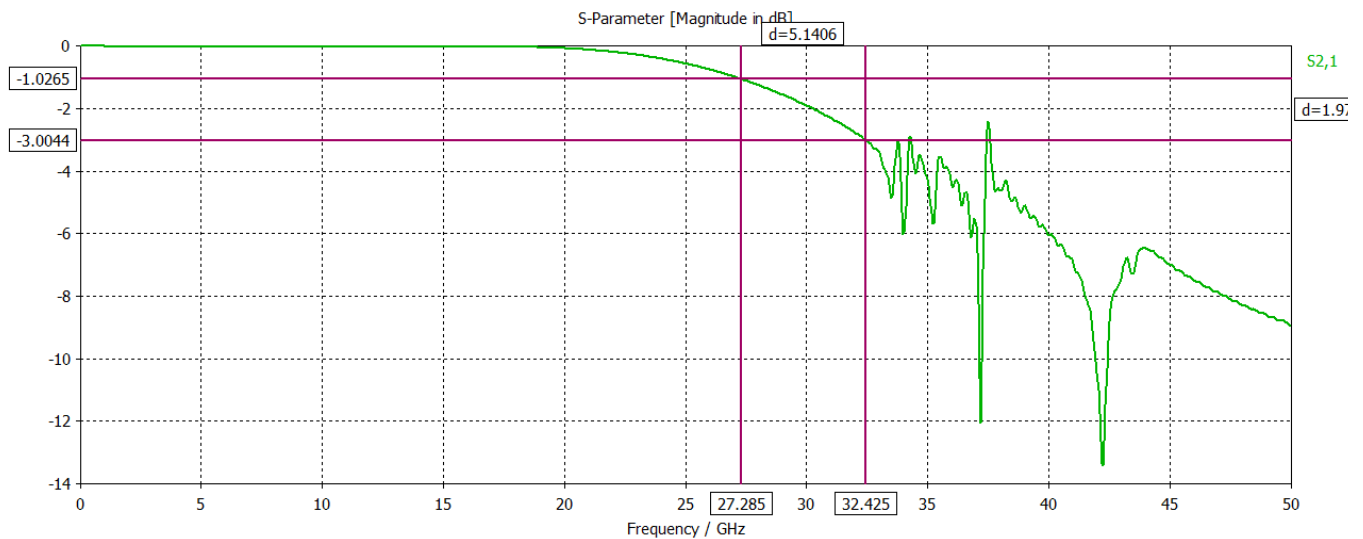

Fig. 2: Simulated Insertion loss

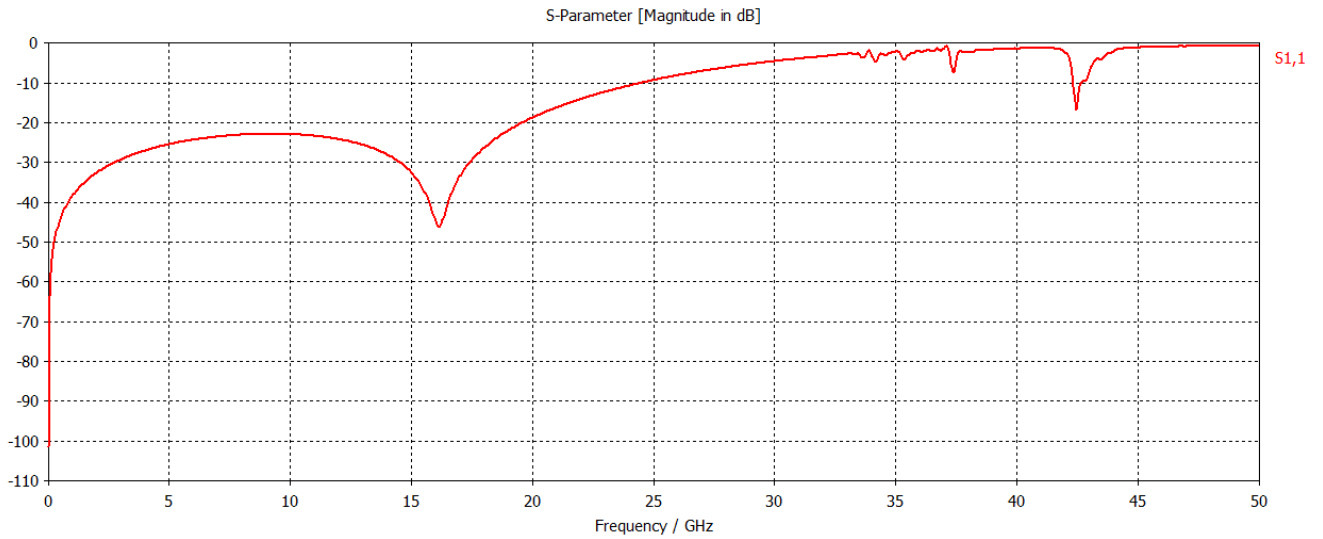

Fig. 3: Simulated Return Loss S_{1,1}

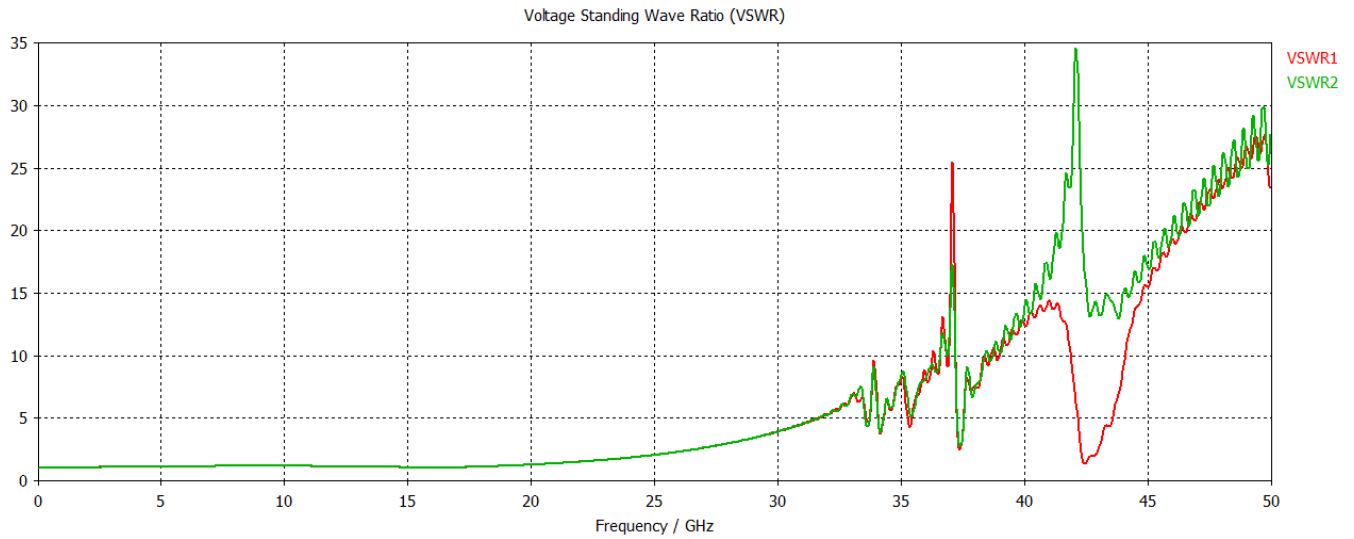

Fig.5 : VSWR