



**Ironwood**  
ELECTRONICS

Tel: (800) 404-0204  
[www.ironwoodelectronics.com](http://www.ironwoodelectronics.com)

# *GHz BGA Socket User Manual*



## **GHZ BGA SOCKET USER MANUAL**

### **Table of Contents**

Selecting a BGA socket	3
Socket Mechanics	3
PCB Requirements	4
Backing Plate	5
BGA Socket Assembly	5
MLF (QFN) Socket Assembly:	6
Torque Driver	7
Vacuum Pen	7
Elastomer Cleaning Procedure	8
Surface Mount (SM) Adaptor	10
Thru Hole (TH) Adaptor	13
GHZ socket Mechanical Specifications	14
Elastomer Specification	14
Heat Sink Specifications	15

## Selecting a BGA socket

The IC package drawing is required to select the correct GHz socket. Go to [www.ironwoodelectronics.com](http://www.ironwoodelectronics.com). Select the “Products” link, then under the “Browse” menu, select the “GHz BGA & MLF socket” link. For 1.27mm, 1mm, 0.8mm and 0.75mm pitch BGA devices, select the “SG-BGA-6xxx” link. For 0.65mm, and 0.5mm pitch BGA device, select the “SG-BGA-7xxx” link. In the table, select the part number that corresponds to your IC size (length mm x width mm), array size (rows x columns) and pitch (mm). **Note:** More than one part number may match your criteria. A frame on the top of the page will show the socket price and links to PDF and JPEG files.

The JPEG file is a picture of socket. The PDF file will have three pages. The first page shows the socket cross sectional views and the material details. The second page shows the recommended PCB layout (Note: BGA pads are not symmetrical to the mounting holes). The third page shows the compatible BGA specification. Check the following four parameters.

1. IC co-planarity – the value should match or be less.
2. Maximum total height of IC should match or be less.
3. Maximum solder ball diameter of IC should match or be less.
4. Maximum and minimum solder ball height should fall within the range.

If any of the above parameters do not match, go back to the table and select a different part number that matched the initial criteria and repeat the four parameter checks. If a part number cannot be found to match IC parameters, please call Ironwood Tech Support @1-800-404-0204.



**Figure 1: GHz BGA Socket**

### Socket Mechanics

GHz BGA sockets provide 6.5 to 10 GHz bandwidth in a small, cost effective ZIF socket for prototype and test applications. The GHz BGA socket is a simple mechanical socket based on elastomer connector technology. The GHz socket is a solder-less socket that can be mounted onto a PCB using screws and nuts. PCBs will require mounting and alignment holes at proper locations (see page 2 of the drawings for recommended PCB layout information). The typical GHz socket is 5mm larger than the maximum IC size. If there are pre-existing holes in

the PCB, a GHz socket can be custom designed to accommodate those holes (please call Ironwood Tech Support @1-800-404-0204).

Figure 1 shows a typical GHz BGA socket. The Z-axis conductive elastomer used in the socket, as a contactor between the IC package and the circuit board, is a low resistance (<0.01Ω) connector. Figure 2 shows an SEM picture of the elastomer. The elastomer consists of a fine pitch matrix (0.1mm x 0.1mm) of gold plated wires (40 micron diameter), which are embedded at a 63-degree angle in a soft insulating sheet of silicone rubber. Another elastomer used for high-

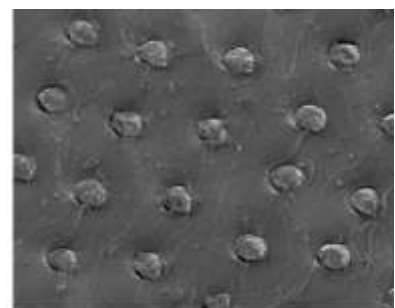

**Figure 2: SEM  
Picture of Elastomer**

density application consists of an ultra fine pitch matrix (0.05mm x 0.05mm) of gold plated wires (20 micron diameter), which are also embedded at a 63-degree angle in a soft insulating sheet of silicone rubber. The insulation resistance between connections with 500V DC is 1000 MΩ. The elastomer is ideal for high-current (50mA per filament) applications where a thin, high-density anisotropic connector is required. The gold-plated brass filaments protrude several microns from the top and bottom surfaces of the silicone sheet. The operating temperature range for the elastomer is -35° to 100° C.

Solder balls from the IC package come in contact with the top end of elastomer wire. The bottom end of the elastomer wire contacts the circuit board pad and thereby makes an electrical path for the signal. The number of wire filaments making contact depends on the solder ball and circuit board pad diameters. Figure 3 shows the cross-sectional side view of the elastomer with the BGA IC. The GHz socket can be summarized as a mechanism in which a downward force applied to an IC compresses its solder balls onto an elastomer, which in turn compresses on the circuit board, thereby making electrical connection.

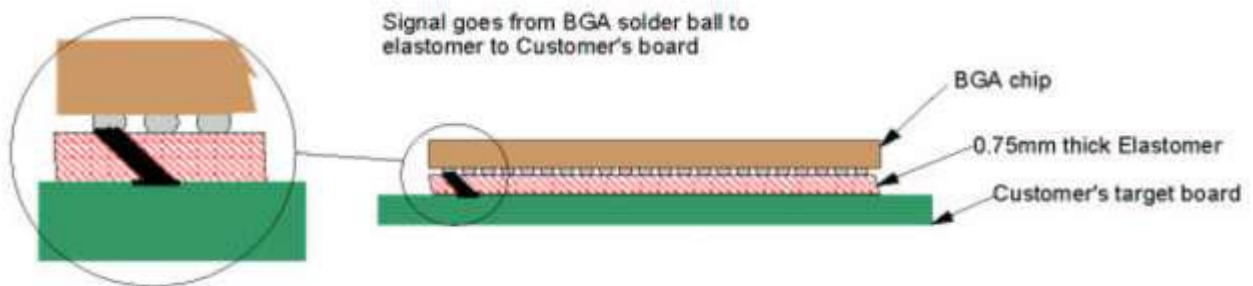

**Figure 3: Elastomer cross-sectional side view**

## PCB Requirements

### General

- Where IC body size is < 30.5mm: GHz socket requires 4 mounting holes.
- Where IC body size is > 30.5mm: GHz socket requires 8 mounting holes.
- Two alignment holes are employed in all sockets. (See drawing for location details).
- BGA pattern is **not symmetrical with mounting holes** due to angled wires in elastomer (see drawing for layout details).
- Please refer to page 2 of the socket drawing for all PCB recommendations.

### Thickness

1.6mm minimum. This will change as per customer's application, environment and usage.

### Finish

SnPb plating or Immersion Au or Immersion Ag. Other plating may be used but testing may be required. Ideally pad surface that is flush or higher than the solder mask is recommended.

**Note:** Our internal tests were successful with 0.001"-0.002" thick solder mask above the pad surface on 0.5mm to 1.27mm pitch elastomer sockets.

### Cleanliness

Isopropyl Alcohol or similar should be used to clean the board surface prior to attaching socket.

## Backing Plate

For an IC body size of 19mm and above, the GHz socket requires a backing plate to prevent the deflection of the target circuit board due to the high downward forces. If the backside of target PCB contains capacitors and resistors, a custom insulation plate with cavities milled for those capacitors and resistors can be designed. The insulation plate sandwiches between the backing plate and the target PCB. Figure 4 shows an example insulation plate.

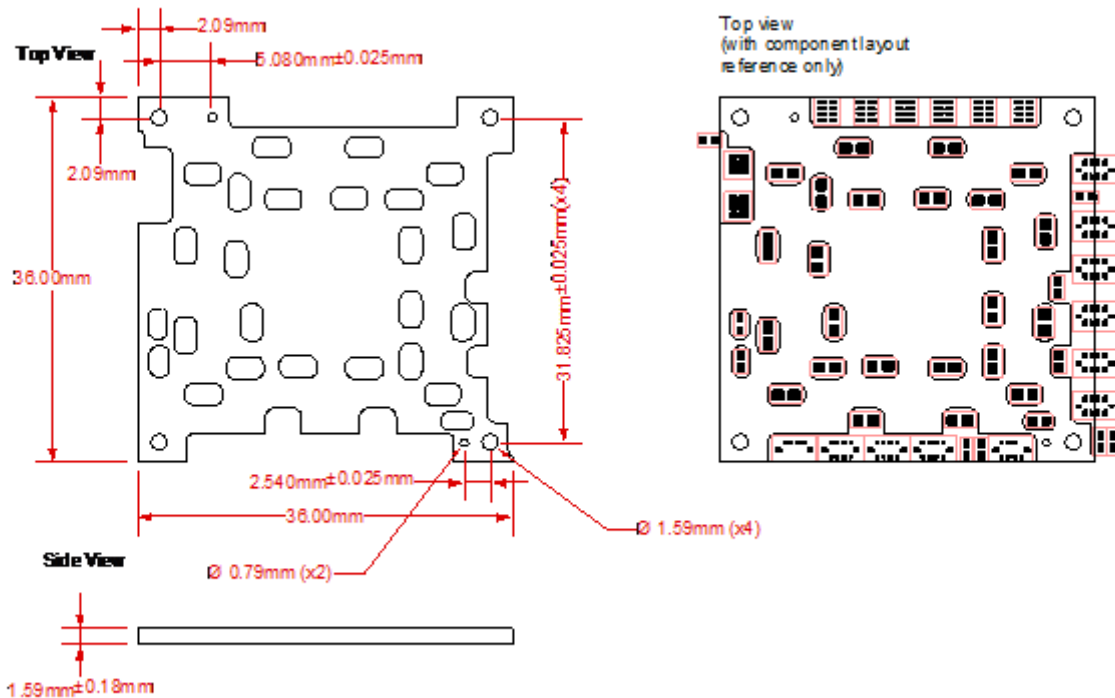

Figure 4: Example Insulation Plate

## BGA Socket Assembly

Refer to figure 5 for graphical illustrations.

1. Install the socket base assembly on the target PCB with the base mounting hardware (provided). Because of the asymmetrical location of the tooling holes, the socket can be assembled onto the target PCB with only one orientation (rotation). **Torque mounting hardware to 6.0 In-Ozf. Do not exceed 10.0 In-Ozf.**
2. Place BGA package (solder ball side down) into the socket. NOTE: BGA orientation on target PCB is critical. If IC frame (optional) supplied, place it over the BGA package.
3. Place the compression plate on top of the BGA package.



4. Install the socket top assembly on to the socket base assembly and swivel to lock into the position. If your socket contains a shoulder screw (silver in color), DO NOT tighten them – they are preset at our factory. If your socket uses a black oxide socket head cap screw, tighten them until they make contact with the lid.
5. Turn the compression screw clockwise, until it makes contact with the compression plate and/or the BGA package.
6. Apply torque specified on page 1 of the part drawing using a torque driver (accurate) or hex key (approximate) supplied with socket. Using hex key, turn an additional 1/8th to 1/4th of a turn.
7. The sockets between 19mm and 27mm will include hex nuts and washers for optional use without the backing plate, it is recommended that the backing plate be used however.

#### **MLF (QFN) Socket Assembly:**

Refer to figure 5 for graphical illustrations.

1. Install the socket base assembly on the target PCB with the base mounting hardware (provided). Because of the asymmetrical location of the tooling holes, the socket can be assembled onto the target PCB with only one orientation (rotation). **Torque mounting hardware to 6.0 In-Ozf. Do not exceed 10.0 In-Ozf.**
2. Place the IC package into the socket using either a vacuum pen or tweezers. MLF type packages pad side down. **NOTE:** The package orientation on the target PCB is critical.
  - 2a. Center small IC packages inside the IC guide using tweezers. Use a microscope if needed.
  - 2b. Press on top of the IC with tweezers. Begin by pressing on the area close to the center of the IC. Then press slightly on all four corners of the IC. **NOTE:** If you are experiencing problems pressing the IC package into the IC guide, it is an indicator that the IC package is not properly centered. Re-center package if necessary.
3. If an IC compression frame (optional) is supplied, place it over the MLF package. Place the compression plate on top of the IC package.
4. Install the socket top assembly on to the socket base assembly and swivel to lock into the position. If your socket contains a shoulder screw (silver in color), DO NOT tighten them – they are preset at our factory. If your socket uses a black oxide socket head cap screw, tighten them until they make contact with the lid.
5. Turn the compression screw clockwise to the specified torque called out on page 1 of the drawing. Be careful not to over-tighten compression screw. Over-tightening will damage the elastomer. **NOTE:** the torque value on page 1 of the drawing is the maximum recommended torque value. Typically, the socket should work with smaller torque settings.

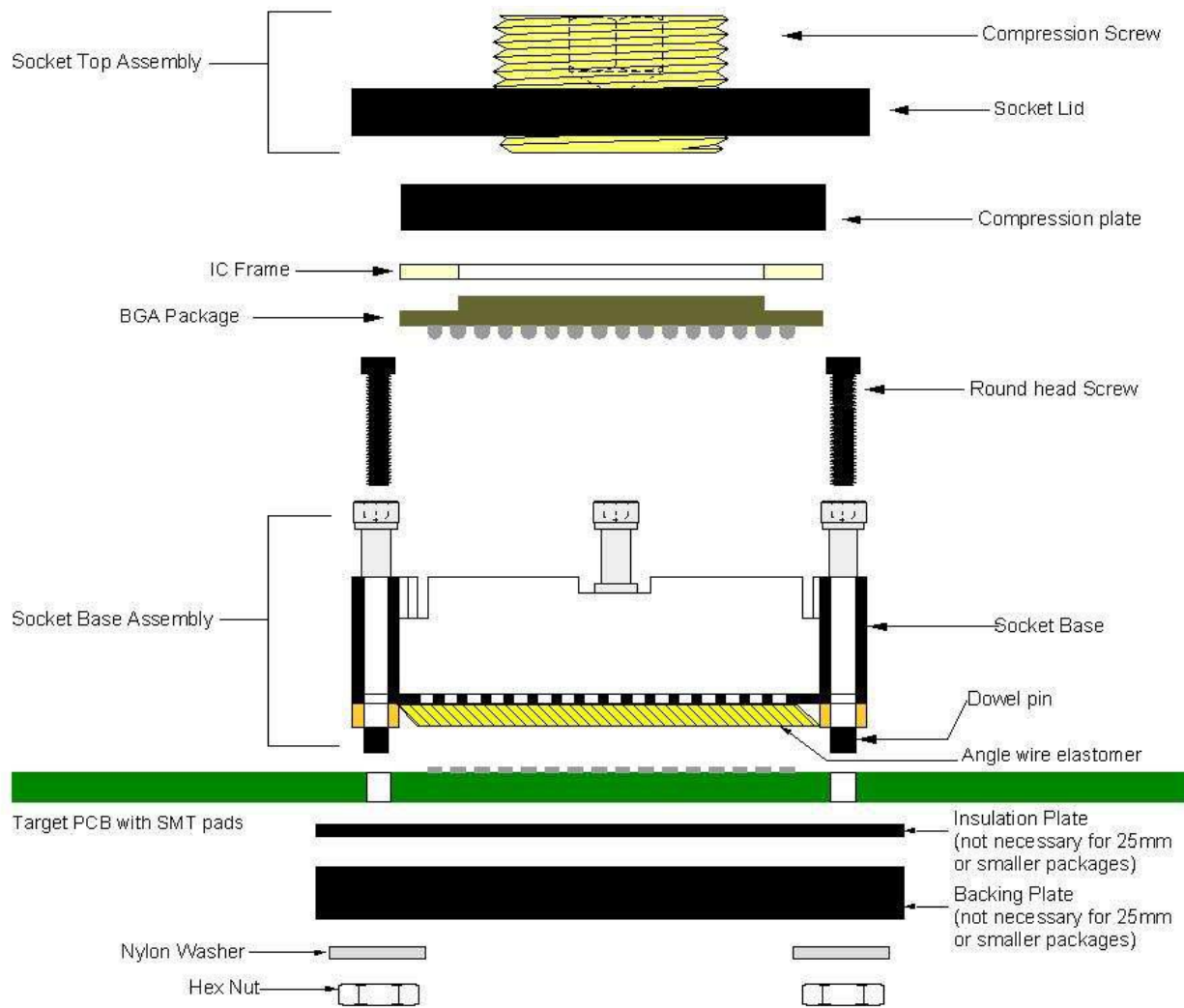

**Figure 5: Exploded View Socket Assembly**

**Torque Driver**

Select the appropriate Ironwood torque driver for your socket torque specified on page 1 of the part drawing. The following adjustable drivers are sold separately and include hex bits listed in table. For other bits, please call Ironwood Tech Support @ 1-800-404-0204.

Part Number	Range	Increments	Included Hex Bits
TL-Torquedriver-01	20-100 in. oz.	16 in. oz.	1.27mm, 3mm, 5mm
TL-Torquedriver-02	48-240 in. oz.	3.2 in. oz.	1.27mm, 3mm, 5mm
TL-Torquedriver-03	80-640 in. oz.	8 in. oz.	1.27mm, 3mm, 5mm
TL-Torquedriver-05	8 in. oz. (preset)	NA	1.27mm, 3mm
TL-Torquedriver-06	16 in. oz. (preset)	NA	1.27mm, 3mm
TL-Torquedriver-09	6-24 in. oz.	0.2 in. oz.	1.27mm, 3mm, 5mm

**Legend**

HBA-1/4" hex bit adaptor (accommodates other 1/4" hex drive insert bits).

**Torque Conversion Factors**

1 in. lbs. = 16 in. Oz. = 0.113 Nm

**Vacuum Pen**

A vacuum pen is recommended for insertion/extraction of ICs.

Figure 7 shows a typical vacuum pen. TL-vacuumpen-01 can be purchased separately. Hand insertion of ICs and extraction using a small tweezers are also acceptable.

**Tweezers:**

A small tweezers is recommended for insertion/extraction of ICs having a body size of 7x7mm or smaller. Figure 6 shows a typical small tweezers with a GHz MLF socket.



**Figure 6: Tweezers with SG-MLF socket**

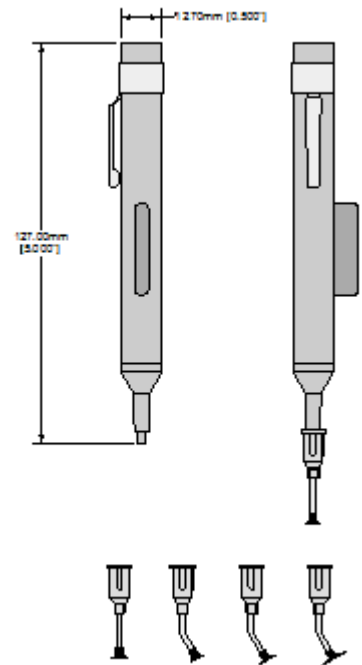

**Figure 7: Vacuum Pen with Attachments**

**Elastomer Cleaning Procedure**

Elastomer cleaning requirements vary with customer applications and are dependent on variables such as contact force, BGA package condition and the environment it is used in. A light cleaning is recommended every 200 to 300 cycles. A thorough cleaning is recommended every 1000 to 2000 cycles. These recommendations are suggestions only, and should be increased or decreased based on observation.

**Note:**

**When socket is not in use, it is a good practice to relieve pressure on contact. This will extend elastomer contact life cycle.**



**Required Tools:** Scotch™ Magic™ Transparent tape or similar or poster putty – Henkel™ DUCPTY2 Poster Putty, Removable/Reusable, Nontoxic or a similar brand. (For more thorough cleaning technique use alcohol, De-Ionized (DI) water, a stiff nylon brush, and clean, dry shop air.)

The Elastomer can be quickly cleaned of dust and debris with a piece of transparent tape approximately 2 inches long. Remove the complete socket assembly from the board. Roll tape loosely around a fingertip, adhesive side out. With finger positioned parallel to the bottom of the elastomer, roll the tape over the surface. (The bottom side of the elastomer can be cleaned without removing it from the socket base assembly). After cleaning the bottom side, carefully remove the elastomer guide and elastomer from the base and clean the top side with a fresh piece of tape.

To use the poster putty, you do not have to remove the elastomer with the guide from the socket base, simply take the socket off the PCB to clean the bottom side of the socket – roll the poster

putty around on the elastomer surface on the bottom – and on the PCB. To clean the inside of the socket, it is best if the socket is re-mounted to the PCB so you don't push the elastomer off the guide. Depending on how big the socket base is you can either use your fingers or some sort of longer tool (pencil, or tweezers will work) and attach the poster putty on the end – be careful not to let the sharp point of the tool stick out as you will damage the elastomer. Roll it around inside the socket or look through a microscope to better see and collect the debris in the socket.

The Elastomer is assembled to the elastomer guide using a silicone adhesive. **DO NOT** remove the elastomer from the guide substrate when cleaning. However, should the elastomer fall out, orientation back into the elastomer guide is critical. The socket will not function properly if the elastomer orientation is incorrect. See figure 8 to reinstall the elastomer into the elastomer guide should it fall out.

**Caution:** the elastomer will absorb liquids and may become deformed if it soaks too much. Do not apply liquids directly to the elastomer or submerge the elastomer in liquid.

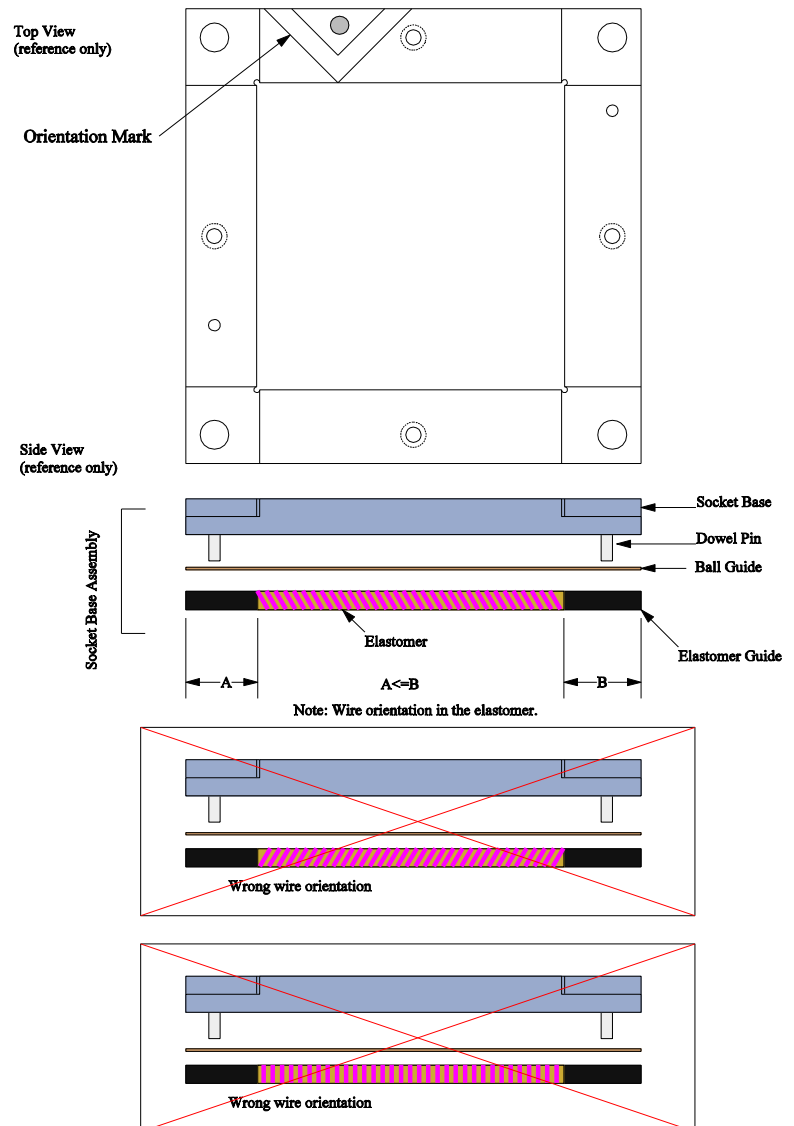
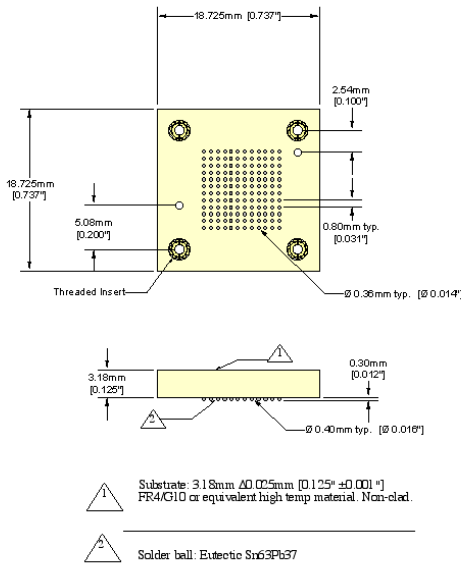

Figure 8: Elastomer Orientation (if re-assembly is necessary)



**Figure 9: Surface Mount Adaptor**

on the topside. It looks very similar to the actual IC except it is slightly larger than the IC. It has threaded insert on four corners. GHz socket can be mounted on to this adaptor using the screws that mate into the threaded insert.

**Materials**

Non-clad FR4, Phosphorous Bronze pins, 63Sn/37Pb Solder balls, threaded insert. The solder balls from IC package come in contact with the top end of elastomer wire. The bottom end of elastomer wire contacts the SM adaptor board pad. The bottom side of the pad is connected to the target circuit board via solder ball and thereby makes an electrical path for the signal. Figure 10 illustrates this concept graphically.

**Assembly**

Ironwood Electronics SMT adaptor can vary greatly in size, mass, and thickness. Because there are many unknown variables for each customer’s situation, it is difficult to recommend an ideal temperature profile for attaching an Ironwood adapter to a particular customer’s target board.

A few of the unknowns which make a profile suggestion difficult:

- 1) The target PCB size, mass
- 2) Number and size of components next to the adapter target pattern
- 3) Reflow oven type
- 4) Type of solder paste/flux used
- 5) Solder stencil characteristics (thickness and aperture size)

Therefore, we offer the following profiles as a guide / reference to mounting our standard and high temperature ROHS Giga-snaP™ and BGA SMT adapters. While the following should work for most scenarios, Ironwood

For a more thorough cleaning, use the stiff nylon brush and a solution of half DI water and half isopropyl alcohol. Wet the brush, scrub the surfaces of the elastomer, and blow both sides dry with clean, dry shop air. After allowing to fully dry, clean the surfaces with the rolled tape method to remove any dust or lint accidentally deposited in the drying process. Only perform the thorough cleaning with the elastomer removed from the elastomer guide.

**Surface Mount (SM) Adaptor**

See figure 9. If the target circuit board already exists or mounting holes cannot be drilled on the board, then a SM adaptor can be used with a GHz socket. SM adaptor can only be made for IC size 27mm or below. SM adaptor has solder balls on the bottom side and round pads

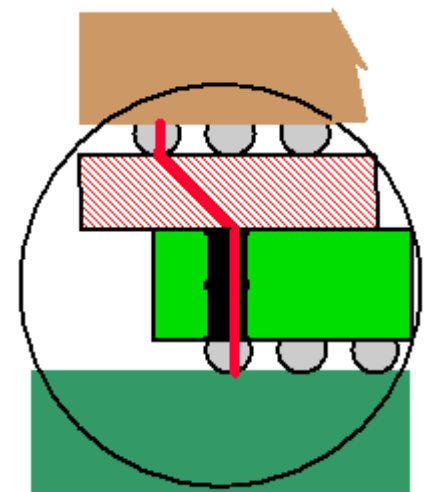

**Figure 10: SM Adaptor Signal Path**

recommends contacting your solder paste / flux manufacturer for proper reflow profiles for your particular set-up and equipment.

**Recommended Reflow Profile – Low Temperature (Non-RoHS)**

Ironwood's SMT adaptor closely emulates a BGA package and therefore can employ similar processes to attach it to a target board. The steps involved in the soldering process are as follows:

- (1) Using a flux dispenser, place a small amount of flux (water soluble or no clean) on the middle of the target PCB lands. Spread the flux evenly over the PCB lands.
- (2) Apply a small amount of TAC flux on opposite corners of the PCB lands.
- (3) Note the target board land pattern orientation and the SM adaptor Pin 1 location. Place the adaptor (solder ball side down) onto the flux and land pattern (align as closely as possible to the land pattern of the target PCB). The SM adaptors are durable enough to be handled by hand, however vacuum pen or pick & place equipment can be used for handling the part.

(4) Surface tension between the adaptor's solder spheres and the target PCB's pads will self-align the part during the reflow process.

(5) Reflow as per (Figure 11):

- Use caution when profiling to insure minimal temperature difference (<math>15^{\circ}</math> C and preferably <math>10^{\circ}</math> C) between components
- Forced convection reflow with nitrogen preferred (50 - 75 PPM)
- Preheat stage temperature ramp rate: <math><2^{\circ}</math> C per second
- Time required in Flux Activation stage: 150 to 180 seconds
- Flux Activation stage temperature range: 150 to 183<sup>0</sup> C
- Time required in Solder stage: 60 seconds
- Maximum temperature 210 - 220<sup>0</sup> C (Do not exceed 10 seconds at maximum temperature)
- Cool-Down stage temperature reduction rate: <math><20</math> C/sec

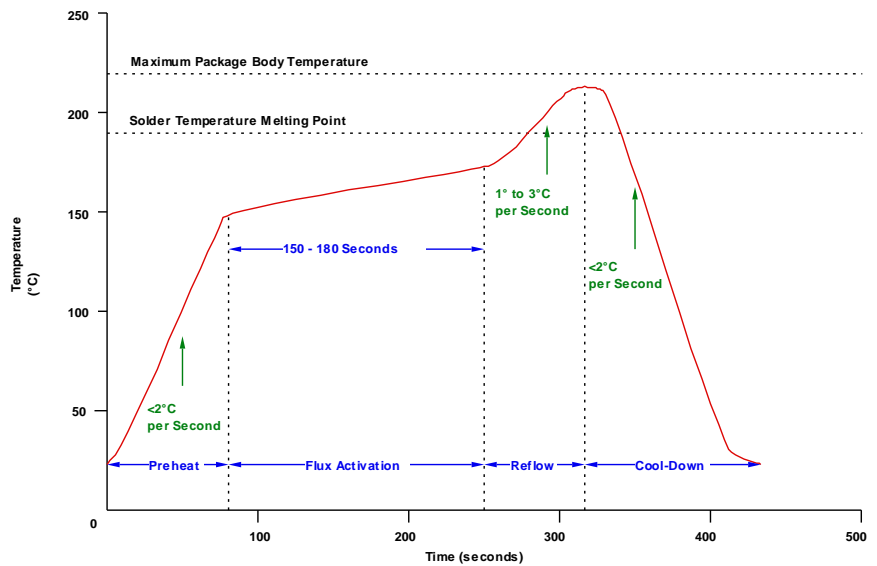

**Figure 11: Recommended Reflow Profile – non RoHS**

NOTE: It may be necessary to adjust the amount of heat when attaching the part, due to the fact that the adaptor mass is different from the actual IC package. Solder sphere spec = 63Sn, 37Pb and its melting point = 183 C

(6) Clean PCB with the flux manufacturers recommended process after reflow. Install the GHz socket on the SM adaptor as per assembly instruction provided in the GHz socket assembly section.



### Recommended Reflow Profile – High Temperature (RoHS)

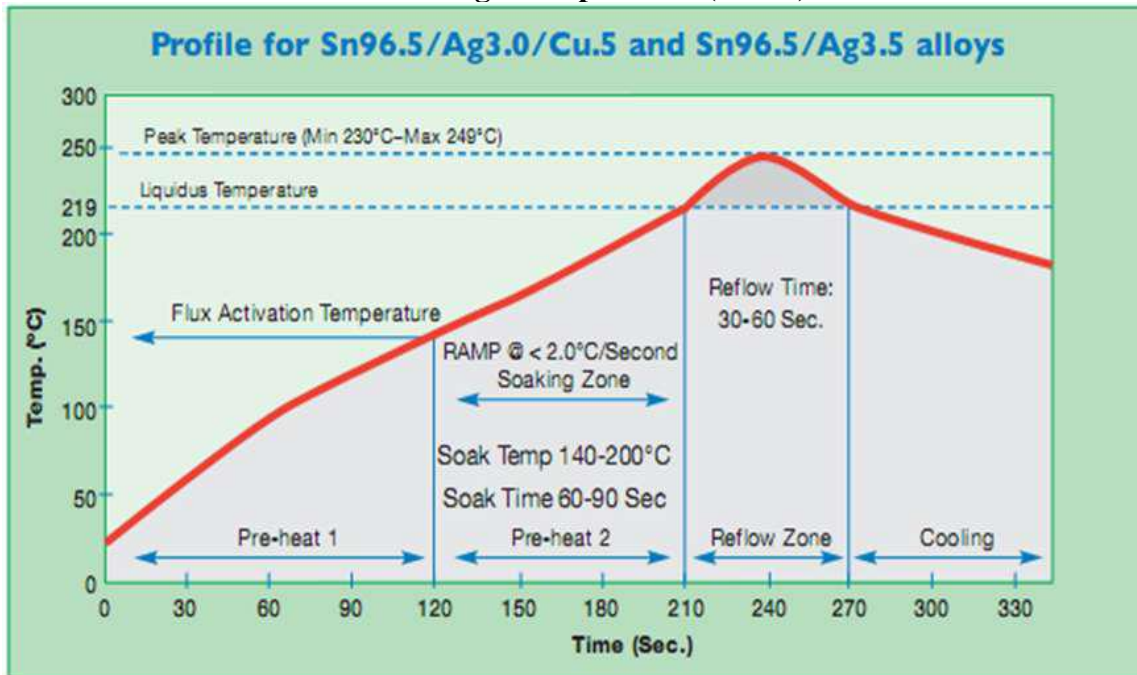

Figure 12: Recommended Reflow Profile – High Temperature (RoHS)

(4) Surface tension between the adapter's solder spheres and the target PCB's pads will self-align the part during the reflow process.

(5) Reflow:

- Use caution when profiling to insure minimal temperature difference (<math><150\text{ C}</math> and preferably <math><100\text{ C}</math>) between components
- Forced convection reflow with nitrogen preferred (50 - 75 PPM)
- Preheat stage temperature ramp rate: <math><20\text{ C per second}</math>
- Time required in Flux Activation stage: 120 seconds
- Flux Activation stage temperature range: 140 to 145 C
- Time required in Solder stage: 30-60 seconds
- Maximum temperature 230 - 249 C (Do not exceed 10 seconds at maximum temperature)
- Cool-Down stage temperature reduction rate: <math><20\text{ C per second}</math>
- NOTE: It may be necessary to adjust the amount of heat when attaching the part, due to the fact that the adapter mass is different from the actual IC package. Solder sphere spec = Sn96.5 Ag3.0 Cu0.5 and its melting point = 219 C

(6) Clean PCB with the flux manufacturers recommended process.

### Thru Hole (TH) Adaptor

If the target circuit board exists with a thru-hole pattern, then a TH adaptor can be used with a GHz socket. TH adapter (See figure 13) has terminal pins on the bottom side and round pads on the topside. It is slightly larger than the IC size. It has threaded insert on four corners. GHz socket can be mounted on to this adaptor using the screws that mate into the threaded insert.

#### Materials

Non-clad FR4, Phosphorous Bronze pins, threaded insert. The solder balls from IC package come in contact with the top end of elastomer wire.

The bottom end of elastomer wire contacts the TH adaptor board pad. The bottom side of the pad is connected to the target circuit board via terminal pins and thereby makes an electrical path for the signal. Figure 14 illustrates this concept graphically.

TH adaptor can be plugged onto a socket receptacle which is surface mount soldered on to the target PCB. Figure 15 illustrates this concept graphically.

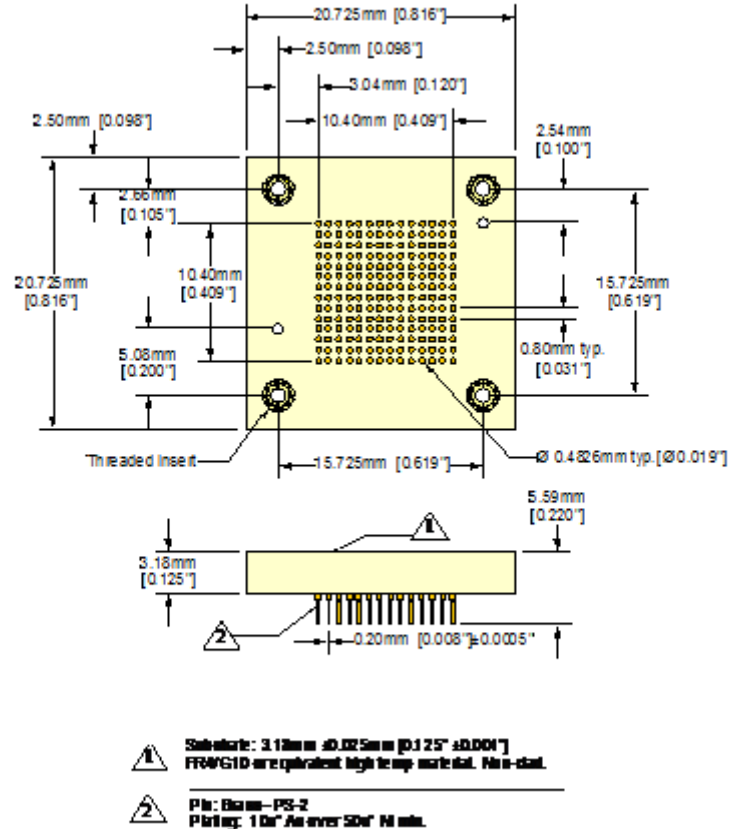

Figure 13: TH Adaptor

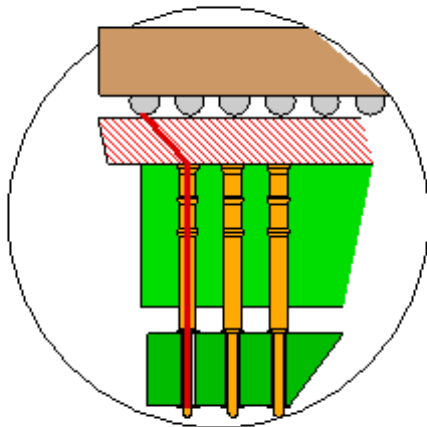

Figure 14: TH Adaptor Signal Path

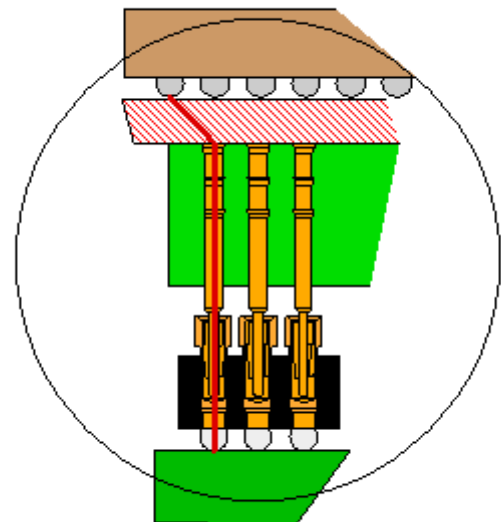

Figure 15: TH Adaptor + Receptacle Signal Path

## GHZ socket Mechanical Specifications

### Individual contact force

BGA Package	Depth of penetration (mm)	Force per ball (grams)
Typical 1.27mm pitch BGA <sup>i</sup>	0.1	20.4
Typical 1.0mm pitch BGA <sup>ii</sup>	0.1	16
Typical 0.8mm pitch BGA <sup>iii</sup>	0.1	8.1

Notes: <sup>i</sup> 0.75mm Nominal solder ball diameter was used in the calculation.

<sup>ii</sup> 0.6mm Nominal solder ball diameter was used in the calculation.

<sup>iii</sup> 0.4mm Nominal solder ball diameter was used in the calculation.

### Conductive Elastomer Life

Needs cleaning after 200 cycles. Shelf life: 1 year

Electrical Specifications	0.5mm Thick	0.75mm Thick
Contact resistance:	23mΩ <sup>1</sup>	25mΩ <sup>1</sup>
Insulation resistance:	1000MΩ <sup>2</sup>	1000MΩ <sup>2</sup>
Self Inductance:	0.11nH <sup>3</sup>	0.28nH <sup>3</sup>
Insertion loss, GSG:	-1dB @ 24.7GHz	-1dB @ 8GHz <sup>3</sup>
Mutual Capacitance	0.020pF <sup>5</sup>	0.020pF <sup>5</sup>
Capacitance to ground	0.204pF <sup>5</sup>	0.204pF <sup>5</sup>
Current carrying capacity:	50mA/wire <sup>6</sup>	50mA/wire <sup>6</sup>

Notes:

<sup>1</sup> Maximum contact resistance with 0.2mm compression (contact resistance will decrease with increased compression). Measurements were taken using 0.4mm square electrodes. The 0.75mm value is interpolated from a test of 0.5mm, 1mm, and 2.0mm elastomers.

<sup>2</sup> The test used 0.5mm wide Au plated electrodes with a 0.5mm gap between them. 500VDC was used with a 1mm thick elastomer compressed 0.35mm.

<sup>3</sup> Measurements were taken with a flat gold plated electrode. The 0.75mm value is interpolated from a test of several elastomer thicknesses ranging from 0.1mm to 2.0mm.

<sup>4</sup> This is a conservative estimate based on 1mm thick elastomer test results with test probes spaced at 0.5mm.

<sup>5</sup> Measurements were taken with test probes at 0.5mm pitch. The 0.75mm value is interpolated from a test of several elastomer thicknesses ranging from 0.1mm to 2.0mm.

<sup>6</sup> The wires are on a 0.1x0.1mm grid and 0.05x0.05mm grid. Multiple wires make contact per solder ball based on its size and depth of penetration. The following table shows typical BGA parameters and its current carrying capability.

Ball pitch (mm)	Ball diameter (mm)	Ball height (mm)	Wire pitch (mm)	# of contacting wire per ball	Total current carrying capacity (mA)
1.27	0.6 – 0.9	0.5 – 0.7	0.1	9 - 16	450 - 800
1.0	0.5 – 0.7	0.4 – 0.6	0.1	9 - 16	450 - 800
0.8	0.3 – 0.5	0.2 – 0.3	0.1	4 - 9	200 - 450
0.5	0.25 – 0.35	0.15 – 0.25	0.05	4 - 9	200 - 450
0.4	0.2 – 0.3	0.12 – 0.18	0.05	4 - 9	200 - 450

## Elastomer Specification

### Operating Temperature

Continuous usage: -35C to +85C, +100C for up to 250 hours

Compression set: 150C for 22hrs

Thickness change: -4.5%

### Vibration

Standard: MIL-STD202, METHOD 204, CONDITION A  
No change in resistance and thickness

**Humidity**

Standard: MIL-STD202, METHOD 106  
Resistance change: 26 mΩ  
Thickness change: -1%

Standard: MIL-STD202, METHOD 103, CONDITION A  
Resistance change: 15 mΩ  
Thickness change: -6%

**Thermal Shock**

Standard: MIL-STD202, METHOD 107, CONDITION A  
Resistance change: -19 mΩ  
Thickness change: -1%

**Heat Sink Specifications**

The graph (Figure 15) shows thermal resistance of the socket as well as socket with a fan (Papst 3412/9 GL, 35.9 CFM, 6" muffin) blowing directly on it. For high power dissipation, a specific heat sink lid can be designed using QFIN software. Please call Ironwood Tech Support @1-800-404-0204.

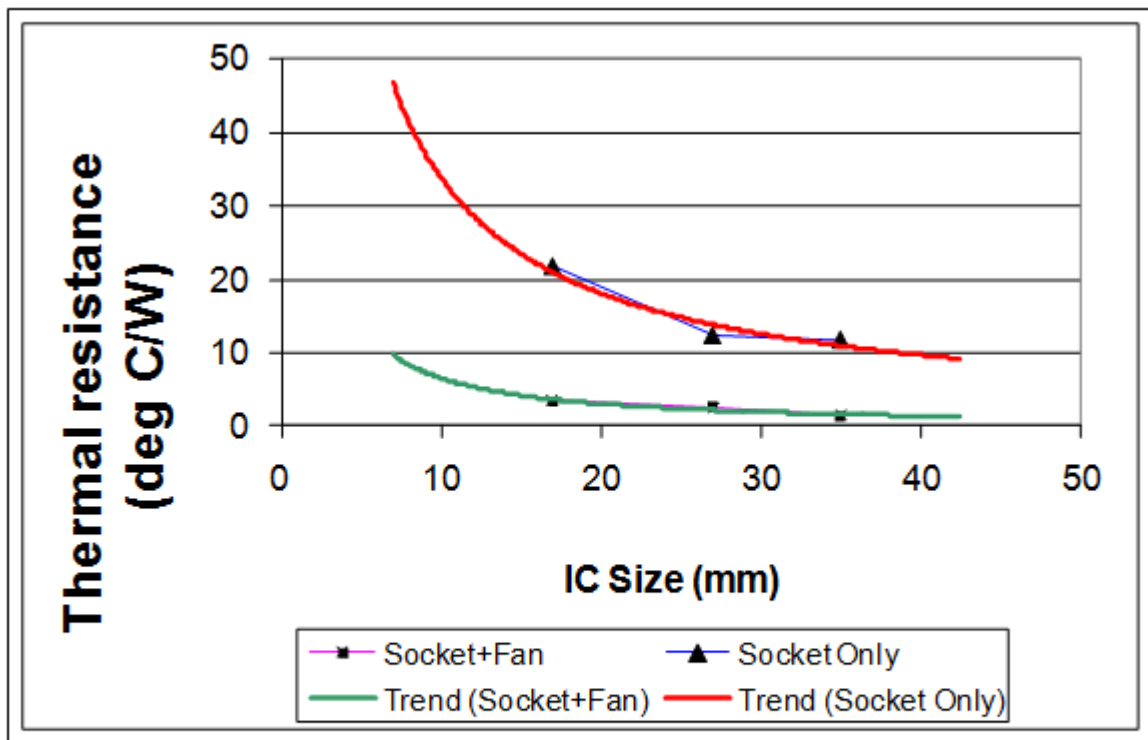

**Figure 15: Heat Sink Characteristics**